

## CDB5471 Evaluation Board and Software

### Features

- Direct Shunt Sensor and Current Transformer Interface for 3-Phase Power
- On-Board Voltage Reference
- On-board crystal for XIN
- Digital Interface to PC
- Lab Windows/CVI™ Evaluation Software
  - “Real-Time” RMS calculation
  - FFT Analysis
  - Time Domain Analysis
  - Noise Histogram Analysis

### General Description

The CDB5471 is an inexpensive tool designed to evaluate the functionality/performance of the CS5471 2-channel A/D Converter. In addition to this data sheet, the CS5471 Data Sheet is required in conjunction with the CDB5471 Evaluation Board.

Two terminal-block connectors serve as inputs to the CS5471's two analog input pairs. The CDB5471 includes an optional voltage reference source for CS5471. A 4.096MHz crystal is provided as a source for CS5471's XIN pin, or an external clock source can be supplied by the user. Digital output data from the CS5471 is transferred to the user's IBM-compatible PC via the included 25-pin parallel port cable.

The CDB5471 includes PC software, allowing the user to perform data capture (includes option for time domain analysis, histogram analysis, and frequency domain analysis). The software also allows real-time RMS calculation/analysis to be performed simultaneously on the instantaneous data from both channels.

### ORDERING INFORMATION

CDB5471

Evaluation Board

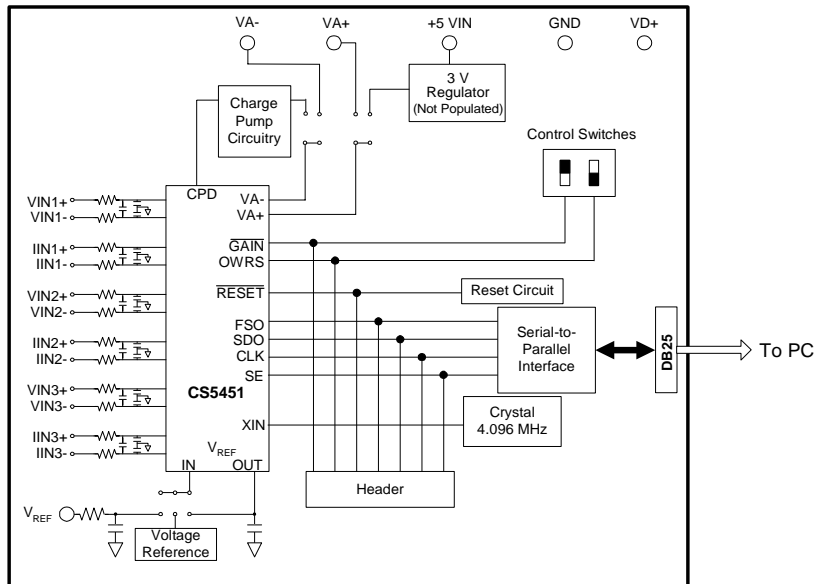

### Preliminary Product Information

This document contains information for a new product. Cirrus Logic reserves the right to modify this product without notice.

---

## TABLE OF CONTENTS

<b>1. INTRODUCTION</b> .....	<b>4</b>
1.1 CS5471 .....	4
1.2 Data Flow on Evaluation Board .....	4
<b>2. HARDWARE</b> .....	<b>5</b>
2.1 Evaluation Board Description .....	5
2.2 Power Supply Connections .....	5
2.2.1 Analog Power Supply .....	5
2.2.2 Digital Power Supply .....	5
2.2.3 Charge Pump Options .....	6
2.3 Eval Board Control - Headers/Switches .....	6
2.3.1 Analog Inputs .....	8
2.3.2 Voltage Reference Input .....	9
2.3.3 Clock Source for XIN .....	9
2.3.4 S1 DIP Switch .....	9
2.3.5 Reset Circuit .....	9
2.3.6 External Signal In/Out Header .....	9
2.3.7 Serial-to-Parallel Interface .....	9
2.3.8 Connecting the Eval Board to PC .....	10
<b>3. SOFTWARE</b> .....	<b>14</b>
3.1 Installing the Software .....	14
3.2 Running the Software .....	14
3.2.1 Getting Started .....	14
3.2.2 The Start-Up Window .....	15
3.2.3 The Conversion Window .....	15
3.2.4 Data Collection Window .....	17
3.2.5 Config Window .....	18
3.2.6 Analyzing Data .....	19
3.2.7 Time Domain Information .....	19
3.2.8 Frequency Domain Information .....	20
3.2.9 Histogram Information .....	21

---

### Contacting Cirrus Logic Support

For a complete listing of Direct Sales, Distributor, and Sales Representative contacts, visit the Cirrus Logic web site at:

<http://www.cirrus.com/corporate/contacts/sales.cfm>

---

*IBM, AT and PS/2 are trademarks of International Business Machines Corporation.*

*Windows is a trademark of Microsoft Corporation.*

*Lab Windows and CVI are trademarks of National Instruments.*

*SPI™ is a trademark of Motorola.*

*Microwire™ is a trademark of National Semiconductor.*

Preliminary product information describes products which are in production, but for which full characterization data is not yet available. Advance product information describes products which are in development and subject to development changes. Cirrus Logic, Inc. has made best efforts to ensure that the information contained in this document is accurate and reliable. However, the information is subject to change without notice and is provided "AS IS" without warranty of any kind (express or implied). No responsibility is assumed by Cirrus Logic, Inc. for the use of this information, nor for infringements of patents or other rights of third parties. This document is the property of Cirrus Logic, Inc. and implies no license under patents, copyrights, trademarks, or trade secrets. No part of this publication may be copied, reproduced, stored in a retrieval system, or transmitted, in any form or by any means (electronic, mechanical, photographic, or otherwise) without the prior written consent of Cirrus Logic, Inc. Items from any Cirrus Logic website or disk may be printed for use by the user. However, no part of the printout or electronic files may be copied, reproduced, stored in a retrieval system, or transmitted, in any form or by any means (electronic, mechanical, photographic, or otherwise) without the prior written consent of Cirrus Logic, Inc. Furthermore, no part of this publication may be used as a basis for manufacture or sale of any items without the prior written consent of Cirrus Logic, Inc. The names of products of Cirrus Logic, Inc. or other vendors and suppliers appearing in this document may be trademarks or service marks of their respective owners which may be registered in some jurisdictions. A list of Cirrus Logic, Inc. trademarks and service marks can be found at <http://www.cirrus.com>.

---

**LIST OF FIGURES**

Figure 1. Power Supply, CS5471, and Oscillator .....	11
Figure 2. Analog Inputs .....	12
Figure 3. Digital Circuitry .....	13
Figure 4. Start-Up Window .....	15
Figure 5. Conversion Window .....	16
Figure 6. Data Collection Window (Time Domain) .....	17
Figure 7. Configuration Window .....	19
Figure 8. Data Collection Window (FFT) .....	20
Figure 9. Data Collection Window (Histogram) .....	21
Figure 10. Silkscreen .....	22
Figure 11. Circuit Side .....	23
Figure 12. Solder Side .....	24

## 1. INTRODUCTION

The CDB5471 Evaluation Board demonstrates the performance of the CS5471 6-channel A/D converter.

The CDB5471 evaluation board provides a quick means of evaluating the CS5471. Analysis software supplied with the CDB5471 allows the user to observe the CS5471's digital output data on the user's PC monitor. The PC software allows the user to quantify the device's performance in the time-domain and frequency domain. The user can save raw data from the CS5471 to a data file, which allows the user to analyze performance with other tools that may be preferable to the user.

### 1.1 CS5471

The CS5471 is a highly integrated Two-Channel Delta-Sigma Analog-to-Digital Converter (ADC) developed for power measurement/metering applications. However the CS5471 has other potential uses in various data acquisition applications, particularly in motor/servo control applications which require very high precision. The CS5471 combines two delta-sigma modulators with decimation filters, along with a master-mode serial interface on a single chip device. The CS5471 was designed for the purpose of performing the A/D conversion operations required at the front-end of a digital single-phase metering system. The six ADC channels can be thought of as a pair of voltage/current-channel ADC's in a digital single-phase power metering application.

The CS5471 contains one programmable gain amplifier (PGA) for the current input. The PGA sets the maximum input level of the current channel at  $\pm 800$  mV DC (for gain = 1x) or  $\pm 40$  mV DC (for gain = 20x). The voltage channel has only the 1x gain setting, and so the range of input levels on the voltage channel is  $\pm 800$  mV DC.

Additional features of CS5471 include a charge pump driver, on-chip 1.2 V reference, and a digital input that can select between two different output word rates. (The two output word rates are equal to  $XIN/2048$  and  $XIN/1024$ .)

The CS5471 requires a 1.2 V reference input on VREFIN. The  $\Delta\Sigma$  modulators and high rate digital filters allow the user to measure instantaneous voltage and current at an output word rate of 4 kHz (or 2000 kHz, depending on the state of the OWRS pin) when a 4.096 MHz clock source is used.

### 1.2 Data Flow on Evaluation Board

The output serial bit-stream from the CS5471 is shifted into an 8-bit latch circuit so that it can be quickly ported to the DB25 connector. From this connector, the data can be sent through the provided 25-pin printer cable to the parallel port of the user's IBM-compatible PC (the PC must run under Windows '95/'98/2000 operating system).

Once the 8-bit segments of data are ported to the user's PC, the LabWindows software (included with this kit) will re-segment the data into the appropriate 16-bit word format for both of the CS5471's two data channels. The data is sent quickly to the user's PC, which allows the software to perform various data processing and graphical illustrations on the digital output data. This includes real-time RMS, variance, and standard deviation calculations for both channels. The output data from each channel can be plotted on-screen in the time domain or in the frequency domain. A histogram function is also included to help the user to evaluate the noise characteristics of each channel. The software can also calculate the mean and standard deviation of the output codes both channels. This feature allows the user to scrutinize the variation of the A/D converters if the user applies constant DC voltage levels to the inputs. RMS calculation is also provided to assist in the quick analysis AC input signals.

## 2. HARDWARE

### 2.1 Evaluation Board Description

The CDB5471 board contains circuitry that will:

- Accept appropriate DC voltage levels from the user's +3V and/or +5V power supplies, and direct this power to the VA+, VD+, VA- and DGND pins of the CS5471.
- Direct the six analog input signals to the six input pairs of the CS5471.
- Supply necessary voltage reference input for the CS5471's VREFIN pin.
- Supply appropriate crystal/oscillator stimulus to the CS5471's XIN pin.
- Direct the output driver signal from the CS5471's charge-pump driver pin (CPD) which is used produce the negative power supply source for the CS5471's VA- pin.
- Provide a reset switch that allows the user to set the CS5471's  $\overline{\text{RESET}}$  pin from logic "1" to logic "0".
- Provide two DIP switches which allow the user to set the logic levels on the CS5471's  $\overline{\text{GAIN}}$  and  $\overline{\text{OWRS}}$  input pins.
- Detect and receive the data frame signal and digital serial output data signals from the CS5471's FSO and SDO pins, and send this output data through the included parallel cable, and up to user's PC.

Several areas of blank proto-board space are provided so that, if desired, the user can interface their own electronic sensor equipment onto the board. The output from these sensors can be wired to the two nearby analog input terminal block connectors, which is then fed to the two analog input channels of the CS5471. Examples of such sensors would include voltage and current transformers, shunt resistors, and resistor divider networks.

The next section of this document describes the various sections of the board. After this, operation of the PC software is described in detail.

### 2.2 Power Supply Connections

The CDB5471 can be used in several different power supply configurations. Table 1 shows the various possible power connections with the required jumper settings. There are various +3 V and +5 V options. The user must supply the +3V, +5V, GND, and sometimes -2V voltage levels needed to power the evaluation board.

#### 2.2.1 Analog Power Supply

Referring to Figure 1, the A+ post supplies power to the positive analog power input pin (VA+) of the CS5471. This post also supplies power to the LT1004 voltage reference (D3) and the optional +3V regulator (U5). If HDR9 is set to the "A-" setting, the A- post can supply the required negative voltage to the VA- pin of the CS5471.

Note that the evaluation board contains the footprints and connectivity which allows the user to install a LM317 voltage regulator (U5), which can be used to create +3 V from a +5 V supply. This option is useful if the user wants to interface the evaluation board to another board that can only operate from a +5V supply. With HDR17 set to "+5V\_IN", one single +5 V supply can be used to provide both a +5V to various microcontrollers and/or other peripheral devices, as well as +3 V for the CS5471. The included schematic diagram shows the circuitry for the +5V regulator circuitry inside a box with dashed lines. These components are not populated when the board is shipped from the factory, but the user can install these components if desired.

#### 2.2.2 Digital Power Supply

The A+ post can be used to supply both the analog power (to CS5471 VA+ pin) as well as the digital power (to CS5471 VD+ pin). However if a separate supply voltage is desired for the digital power

supply, the “VD+” banana connector post can be used to independently supply a separate digital power supply to the input of the CS5471 (VD+ pin), the 4.096 MHz oscillator (U1), and circuitry for the parallel port interface. This is controlled by the setting on HDR18.

The user should note that the CS5471 can operate with a digital supply voltage of either +3V or +5V. This voltage is defined as the voltage presented across VD+ and DGND.

### 2.2.3 Charge Pump Options

The output from CS5471’s charge-pump driver pin (CPD) can be used to generate a -2V supply when the proper jumper settings are selected on HDR9. This -2V supply can be used as the negative power supply connection for the CS5471’s VA- pin. Re-

ferring to Figure 1, circuitry for a charge-pump circuit is included on-board. The charge pump circuit consists of capacitors C11, C12, and C36, and diodes D1 and D2.







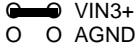
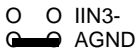

As an alternative to using the charge pump circuit, the user can supply an off-board -2V DC power source to the “A-” banana connector. This option is controlled by the setting on HDR9.

### 2.3 Eval Board Control - Headers/Switches

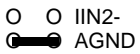
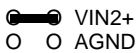
Table 2 lists the various adjustable headers and switches on the CDB5471 Evaluation Board, as well as their default settings (as shipped from the factory). The header settings can be adjusted by the user to select various options on the evaluation board. These options are described further in the following paragraphs.

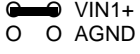
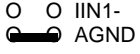
Power Supplies		Power Post Connections							
Analog	Digital	A+	A-	GND	D+	+5 V_IN	HDR9	HDR17	HDR18
+3	+3	+3	-2	0	+3	NC	A- CPD	+5V_IN A+	VD+ V+
+3	+3	+3	-2	0	NC	NC	A- CPD	+5V_IN A+	VD+ V+
+3	+3	+3	NC	0	+3	NC	A- CPD	+5V_IN A+	VD+ V+
+3	+3	+3	NC	0	NC	NC	A- CPD	+5V_IN A+	VD+ V+
+3	+3	NC	-2	0	NC	+5	A- CPD	+5V_IN A+	VD+ V+
+3	+3	NC	NC	0	NC	+5	A- CPD	+5V_IN A+	VD+ V+
+3	+5	+3	-2	0	+5	NC	A- CPD	+5V_IN A+	VD+ V+
+3	+5	+3	NC	0	+5	NC	A- CPD	+5V_IN A+	VD+ V+
+3	+5	NC	-2	0	+5	+5	A- CPD	+5V_IN A+	VD+ V+
+3	+5	NC	NC	0	+5	+5	A- CPD	+5V_IN A+	VD+ V+
+5	+3	+5	0	+2	+5	NC	A- CPD	+5V_IN A+	VD+ V+

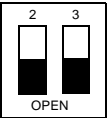
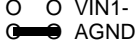
**Table 1. Power Supply Connections**

Name	Function Description	Default Setting	Default Jumpers
HDR1	Used to switch IIN3+ on the CS5471 between J2 and AGND.	IIN3+ Set to BNC J2	
HDR2	Used to switch VIN3- on the CS5471 between J3 and AGND.	VIN3- Set to BNC J3	
HDR3	Used to switch VIN3+ on the CS5471 between J1 and AGND.	VIN3- Set to BNC J1	
HDR4	Used to switch IIN3- on the CS5471 between J4 and AGND.	IIN3- Set to BNC J4	
HDR5	Used to switch VIN2- on the CS5471 between J6 and AGND.	VIN2- Set to BNC J6	
HDR6	Used to switch IIN2+ on the CS5471 between J7 and AGND.	IIN2+ Set to BNC J7	
HDR7	Used to switch IIN2- on the CS5471 between J5 and AGND.	IIN2+ Set to BNC J5	
HDR8	Used to switch VIN2+ on the CS5471 between J8 and AGND.	VIN2+ Set to BNC J8	
HDR9	Used to switch between external VA- and on-board CS5471 charge-pump circuit, CPD	CPD active	A- O O CPD 
HDR10	Used to switch VIN1+ on the CS5471 between J9 and AGND.	VIN1+ Set to BNC J9	
HDR11	Used to switch IIN1- on the CS5471 between J12 and AGND.	IIN1- Set to BNC J12	
HDR12	Used to switch IIN1+ on the CS5471 between J10 and AGND.	IIN1- Set to BNC J10	
SW1	S1-1 sets logic level on CS5471 $\overline{\text{GAIN}}$ input pin S1-2 sets logic level on CS5471 OWRS input pin	SW1-2 Open ( $\overline{\text{GAIN}}=x1$ ) SW1-1 Open ( $\overline{\text{XIN}}/1024$ )	
HDR13	Used to switch VIN1- on the CS5471 between J11 and AGND.	VIN1- Set to BNC J11	
HDR14	Used to switch the VREFIN from external VREF post connector, to the on board LT1004 reference, or to the on-chip reference VREFOUT. Refer to Table 3.	VREFIN Set to on-chip reference VREFOUT	

**Table 2. Default Header Settings**

Name	Function Description	Default Setting	Default Jumpers
HDR15	Controls the source for the CS5471 XIN clock input.	Set to on-board 4.000 MHz crystal (U1).	
HDR16	This header should always be shorted.	Short this header	
HDR17	Determines whether the main analog supply will be powered from the A- post, or from the regulated 3V voltage (generated from the +5V_IN) post input.	Set to A-	
HDR18	Choose whether the digital circuitry will be powered by main analog supply, or powered by separate digital supply (through VD+ post).	Set to main analog supply	

**Table 2. Default Header Settings (Continued)**

### 2.3.1 Analog Inputs

Refer to Figure 2. The settings on the 14 analog input headers (2 headers per channel) which are designated as HDR10 through HDR13, determine which of the input lines will carry a signal, and which input lines may be grounded. They can be configured to accept either a single-ended or differential signal. Using the voltage channel as an example (see Figure 2), note that HDR10 sets the input to the positive side of the first voltage channel input (VIN1+ pin). HDR13 sets the input to the negative side of the first voltage channel input (VIN1- pin). In a single-ended input configuration, HDR13 would be set to the “AGND” setting, and HDR10 would be set to “VIN1+” and would conduct the single-ended signal. In a differential input configuration, HDR13 would be set to “VIN1-” and HDR10 would be set to “VIN1+” and this pair of inputs would form the differential input pair into the VIN1+ and VIN1- pins of the CS5471.

**WARNING: DANGER!** *One of the possible applications for the CS5471 includes data acquisition for a power metering system. However, the user should not attempt to directly connect any leads from a high-voltage power line to the evaluation board inputs, even if the current/voltage levels are gain reduced by resistive dividers and/or shunts. Because the ground terminal of the parallel cable (from the PC) is near or at earth ground potential,*

*the ground node on the evaluation board will also be forced to earth ground potential. Serious damage and even personal injury can occur if a “hot” voltage main is connected to any point on the evaluation board, including the analog input connectors. Such power line signals must be isolated by current/voltage transformers and reduced in magnitude before they can be safely applied to the evaluation board.*

Several patch-circuit areas are provided near the voltage/current input headers, in case the user wants to connect special sensor circuitry to the analog inputs (such as transformers, shunt resistors, etc., for sensory the voltage/current on a single-phase power line). For the input channel, a Shunt Resistor or Current Transformer can be mounted in these areas and connections can be made to current-channel input pair. Likewise, the three channels, a Voltage Divider or Voltage Transformer can be connected to the CS5471’s voltage input pair. Note from Figure 2 that a simple R-C network filters each sensor’s output to reduce any interference picked up by the input leads. The 3 dB corner of the filter is approximately 50 kHz differential and common mode.

Note that the CDB5471 Evaluation Board is also used as the evaluation board for the CS5451 A/D converter, which is a 6-channel version of the CS5471. The user can use this board to the evalu-



ate CS5451 by obtaining a CS5451 sample and connect it in place of the CS5471 device. Then the remaining four input channels serve as the inputs to the CS5451's four additional input pairs.

Other header options listed in Table 2 allow the user to set the source of the input clock signal and the source of the voltage reference (VREFIN) input, etc. The voltage reference options and clock input options are discussed next.

### 2.3.2 Voltage Reference Input

To supply the CS5471 with a suitable 1.2 V voltage reference input at the VREFIN pin, the evaluation board provides three voltage reference options: on-chip, on-board, and external. See HDR14 as shown in Figure 1. Table 3 illustrates the available voltage reference settings for HDR14. With HDR14's

Reference	Description	HDR14
LT1004	Select on board LT1004 Reference (5 ppm/°C)	 LT1004 VREFOUT EXT VREF
VREFOUT	Select reference supplied from CS5471 VREFOUT pin	 LT1004 VREFOUT EXT VREF
EXTVREF	Select external reference	 LT1004 VREFOUT EXT VREF

**Table 3. Reference Selection**

jumpers in position “VREFOUT,” the CS5471's on-chip reference provides 1.2 volts. With HDR14 set to position “LT1004,” the LT1004 provides 1.23 volts (the LT1004 temperature drift is typically 50 ppm/°C). By setting HDR14's jumpers to position “EXT VREF,” the user can supply an external voltage reference to J16 connector post (VREF) and AGND inputs.

### 2.3.3 Clock Source for XIN

A 4.000 MHz crystal is provided to drive the XIN input of the CS5471. (See Figure 1.) However, the user has the option to provide an external oscillator signal for XIN, by switching the setting of HDR15.

### 2.3.4 S1 DIP Switch

Referring to Figure 3, the two single-pole single-throw switches on SW1 DIP switch should be used to control the logic settings on the CS5471's OWRS pin and  $\overline{\text{GAIN}}$  pin. When these SW1 switches are set to “OPEN” the corresponding pin on CS5471 is set to D+ potential, which creates a logic-high state. When the user closes either of these SW1 switches, the corresponding pin on CS5471 is grounded, which creates a logic-low state on the pin.

### 2.3.5 Reset Circuit

Circuitry has been provided which allows the user to execute a hardware reset on the CS5471. (See Figure 3). By pressing on the S1 switch, the  $\overline{\text{RESET}}$  pin on the CS5471 will be held low until the switch is released.

### 2.3.6 External Signal In/Out Header

Note that HDR16 is included on the CDB5471 Evaluation Board as a header that is normally left unconnected. This header provides a way for the user to interface the CDB5471 Evaluation Board to other prototype boards, calibrators, logic analyzers, other peripherals, etc. in order to further evaluate the CS5471 device and/or to use the evaluation board as a platform for the prototype development of a digital power metering solution. However, note that the CDB5471 Evaluation Board is not intended to be integrated directly into a commercial digital power meter. The layout of the board is not optimized for practical power metering situations.

### 2.3.7 Serial-to-Parallel Interface

Glue-logic on the evaluation board converts the CS5471 serial data into 8-bit segments (bytes). The bytes are sent to the DB25 connector (J17), and then through the standard printer cable to the user's PC. This section briefly describes the operation of the digital circuitry on the CDB5471 that provides the 8-bit parallel data to the PC. Refer to Figure 3.

The user should recall from CS5471 Data Sheet that the serial interface on the CS5471 device is a “master-mode” interface, which means that the device provides the clock. Once the CS5471 is powered on, the SCLK pin produces a clock signal, and data is sent out on the SDO pin of the device. When the evaluation software is instructed (by the user) to acquire data through the parallel interface, a two-step process is performed: First the software synchronizes itself to the frame rate of the CS5471, then the software acquires multiple frames of data from the CS5471.

### 2.3.7.1. Synchronization

When the software is commanded to acquire data, the software will first synchronize itself to the frame rate of the CS5471 (see CS5471 Data Sheet). This is done by measuring the amount of time between rising and falling edges of the “BUSY” signal. (BUSY will change state every time the CS5471 issues eight SCLKs--See next section for a more detailed description.) By measuring this time period, the software can determine the idle period of the frame, which allows it to be prepared to collect a complete frame’s worth of data when the next CS5471 frame is received. This acquisition sequence is described next.

### 2.3.7.2. Acquisition

Referring to Figure 3, the CS5471’s SCLK line is used to clock the 8-bit serial-in/parallel-out shift-register (U7) which accepts the serial data on SDO and shifts it into the 8 output bits QA-QG. The SCLK signal is also fed into the up/down counter U6 and after every 8 SCLKs, the “QC” pin of U6 will latch the QA-QG output bits of U6 into the 8-bit D-Flip-Flop (U3). While this is happening, the software monitors the “BUSY” signal (from the “QD” pin of U6). BUSY is the critical handshake signal. A rising *or* falling transition on BUSY indicates to the software that it is now time to collect another byte of data from the latched output on U3.

After sixteen SCLKs, the PC software has acquired two bytes (16 bits) which represents one data sample. The 4-bit up/down counter (U6) will roll over after every 16 SCLKs. (Note that U6 is cleared by the CS5471’s FSO signal at the beginning of each frame, which insures that the counter begins the frame in the correct state--cleared). This sequence, which lasts for 16 SCLKs, is performed a total of six times, although only the first two repetitions of this sequence are relevant. In the first two sequences, the two 16-bit words from the CS5471 are acquired by the PC. The data contained in the remaining four sequence executions will be meaningless, as the state of the CS5471’s SDO pin is undefined during the last 64 clocks of each data frame.

After the sixth 16-bit word is acquired, the software recognizes that the end of a data frame has been reached, and it will continue to wait for the next transition on the “BUSY” line. This will not occur until the first 8 SCLKs of the next frame are sent from the CS5471. Various other signals in Figure 3 (STRB, FEED, ACK, etc.) are not used during data capture and are only used for testing (internal use only).

### 2.3.8 Connecting the Eval Board to PC

The CDB5471 connects to the user’s IBM-compatible PC with the included 25-pin parallel port cable. ***The user should not connect this cable between the CDB5471 and the parallel port on the PC until all of the header options in Table 2 have been set to appropriate settings and the user has applied power to the CDB5471.*** The parallel cable attached to the CDB5471 Evaluation Board at J17. After connecting the parallel port cable between the PC and CDB5471, the user should always actuate (press down on) the “RESET” switch (S1) at least one time before performing any other evaluation activities.

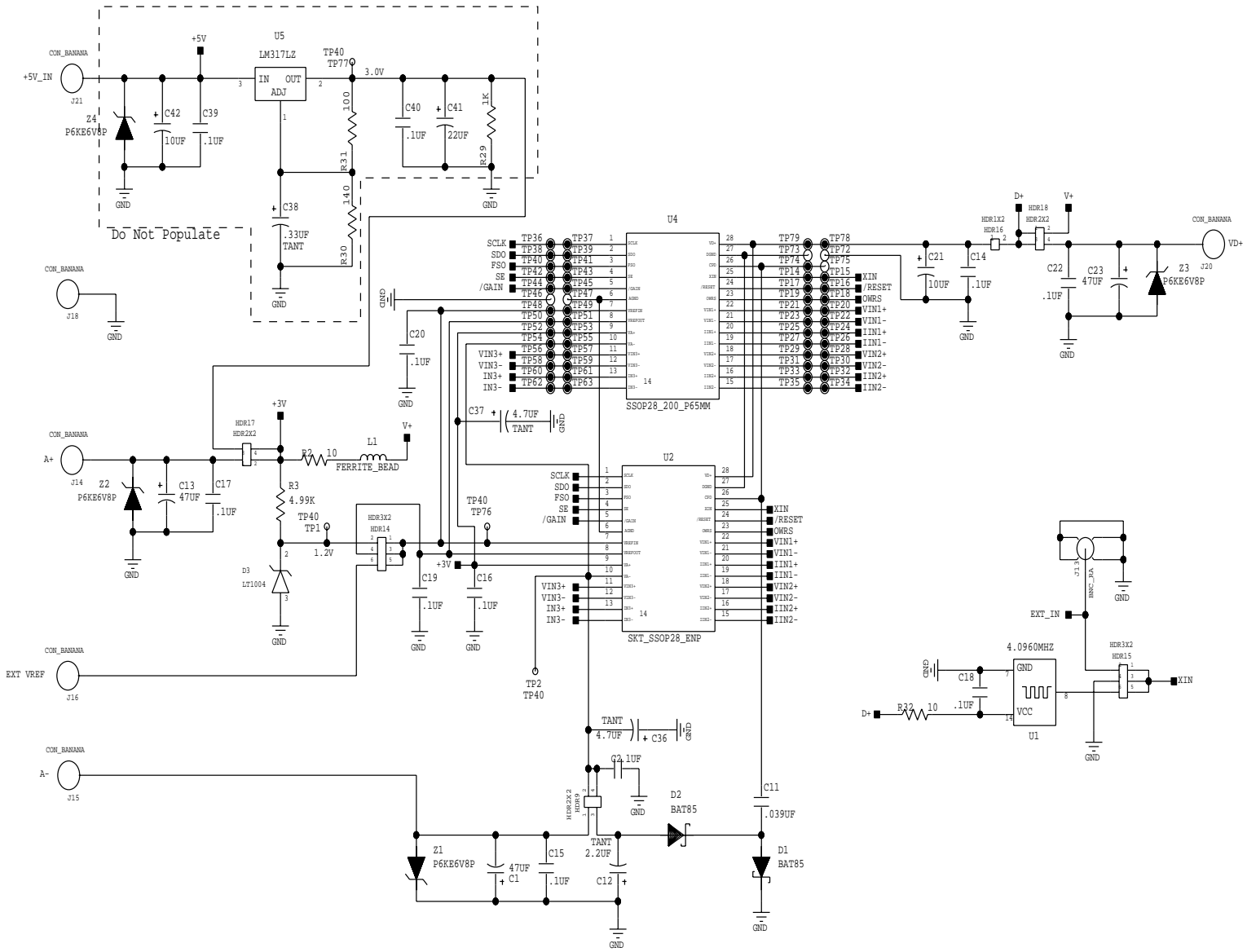
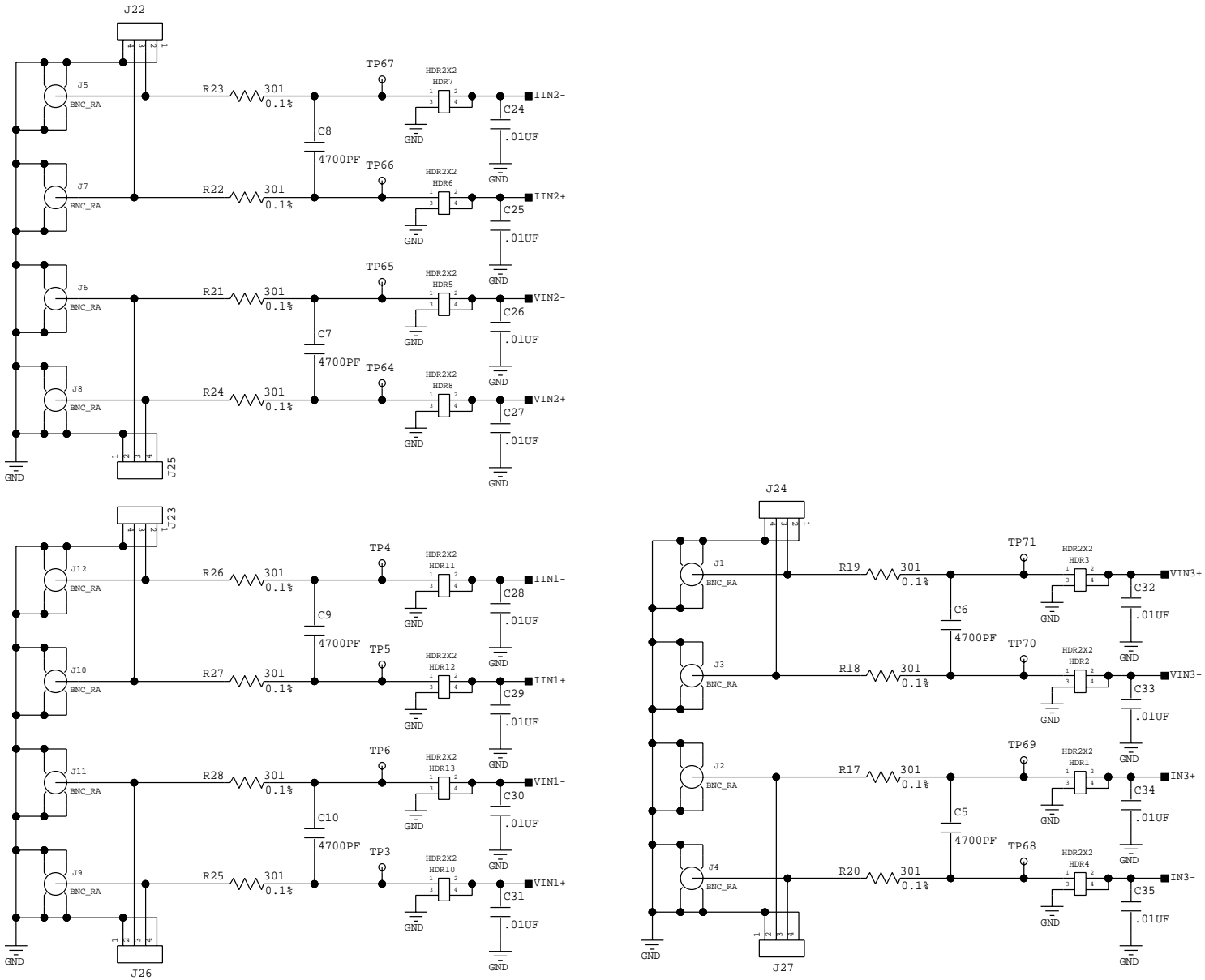

Figure 1. Power Supply, CS5471, and Oscillator



**Figure 2. Analog Inputs**



### 3. SOFTWARE

The evaluation software was developed with Lab Windows/CVI™, a software development package from National Instruments. The software is designed to run under Windows 95™ or later, and requires about 3 MB of hard drive space (2 MB for the CVI Run-Time Engine™, and 1 MB for the evaluation software). After installing the software, read the readme.txt file for any last minute updates or changes. More sophisticated analysis software can be developed by purchasing the development package from National Instruments (512-794-0100).

#### 3.1 Installing the Software

Installation Procedure:

- 1) Turn on the PC, running Windows 95™ or later.
- 2) Insert the Installation Diskette #1 into the PC.
- 3) Select the Run option from the Start menu.
- 4) At the prompt, type: A:\SETUP.EXE <enter>.
- 5) The program will begin installation.
- 6) If it has not already been installed on the PC, the user will be prompted to enter the directory in which to install the LabWindows CVI Run-Time Engine™. The Run-Time Engine™ manages executables created with Lab Windows/CVI™. If the default directory is acceptable, select OK and the Run-Time Engine™ will be installed there.
- 7) After the Run-Time Engine™ is installed, the user is prompted to enter the directory in which to install the CDB5471 software. Select OK to accept the default directory.
- 8) Once the program is installed, it can be run by double clicking on the EVAL5451 icon, or through the Start menu.

Note: The software is written to run with 640 x 480 resolution; however, it will work with 1024 x 768 resolution. If the user interface seems to be a little small, the user might consider setting the display settings to 640 x 480. (640x480 was chosen to accommodate a variety of computers).

#### 3.2 Running the Software

##### 3.2.1 Getting Started

The CDB5471 Evaluation software allows the user to obtain, display, and save data that is acquired by the CS5471 chip. Before running the software, the first step is to make sure that all of the headers that are listed in Table 2 are set to an appropriate setting, the exact setting should be determined by the user. Next, with the user's DC power supplies still turned off, the user should connect the necessary power leads to the banana jack power connectors on the evaluation board. Refer to Table 1 for various acceptable power supply connection configurations. Then at this time the user should turn on their DC power supplies, which should apply power to the CDB5471. Several test point locations are available on the evaluation board. The user can check these test points with a voltmeter, to make sure that the voltages at these test points are at the expected levels. When the user has verified that the power supply levels are constant, the user should connect the included 25-pin cable between J17 of the evaluation board and the parallel port on the user's PC. The user should then press down on the S1 "RESET" switch, and make sure to hold it down for at least ~0.5 seconds before releasing. Finally, the user can start the PC software. To start the software, double click on the EVAL5451 icon, or initiate through the Start menu.

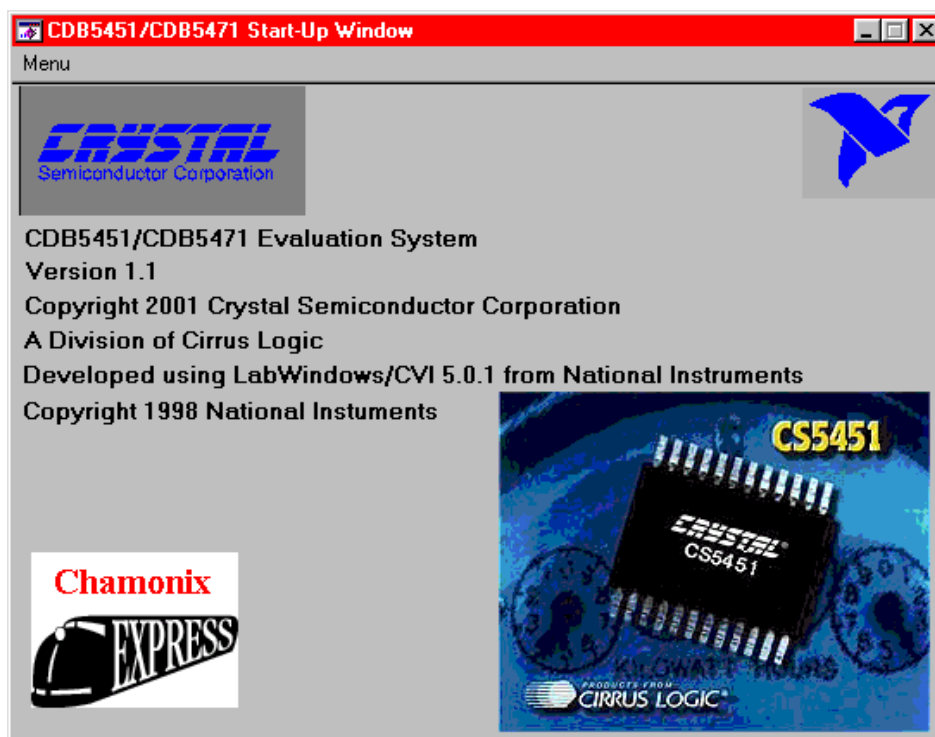

Figure 4. Start-Up Window

### 3.2.2 The Start-Up Window

When the software first executes, the user should see the Start-Up Window appear on the user’s PC monitor. This window is shown in Figure 4. From this window, the user can navigate to three other main windows: the Conversion Window, the Data Collection Window, and CS5471 Pinout Diagram. (The CS5451 Pinout Diagram is also included in a fourth window.) To navigate to these windows, use the mouse to click on the “Menu” item, which is located towards the upper left corner of the Start-Up Window. “Menu” is a pull-down menu which contains four options. From this pull-down menu, the user can select any of the three windows mentioned above, and once this is done, the new window should appear. A fourth option called “Exit” should be selected when the user wants to terminate execution of the evaluation board software program.

If the user selects the “CS5471 Pinout Diagram” option in the “Menu” pull-down, the software will

display a window which contains the pin diagram of the CS5471. This pin diagram is included for the user’s reference. Note that this window has no actual functionality.

The functionality of the Conversion Window and the Data Collection Window is described next.

### 3.2.3 The Conversion Window

Refer to Figure 5. After the user presses on the green-colored “START” button in this window, the software will begin to collect data for both channels of the CS5471. For each channel, a certain number of instantaneous data samples from the CS5471 are bundled together. The period over which each bundle of samples is taken is called a “computation cycle.” The user controls the number of instantaneous data samples that will be taken (per channel) during one computation cycle by adjusting the number in the box labeled “Evaluation Software Cycle Count:.” Note that the default value for this is set to 4000. Thus during every computation cycle, the PC software will acquire 4000 samples

(from both channels) and it will update the on-screen results of both channels after calculating the results on each successive set of 4000 samples. The results that are displayed on this screen are therefore updated after each computation cycle. Note that the results in the very first computation cycle (after the “START” button has been activated) will not be valid. Accuracy of the Mean, Std. Dev. and RMS results will increase as the “Samples to Average” value is increased.

The user should understand how to interpret the values that are displayed in the array of number boxes in the Conversion Window. **For CDB5471, only the results displayed in the “Voltage 1” and “Current 1” rows are valid.** The result values

that are displayed in these numeric output boxes are all expressed on a normalized scale. The highest value (0.999...) represents the highest digital output code that can be issued from the CS5471 (which is +32767), while the lowest value -0.999... represents the most negative output code that can be issued from the CS5471 (which is -32768). This is because the CS5471 issues instantaneous output codes as two’s complement 16-bit words. Therefore, the range of values that can be returned from the CS5471 are between -32768 and +32767. The CS5471 issues instantaneous data, and every computation cycle, the software computes/displays the quantities which are described below:

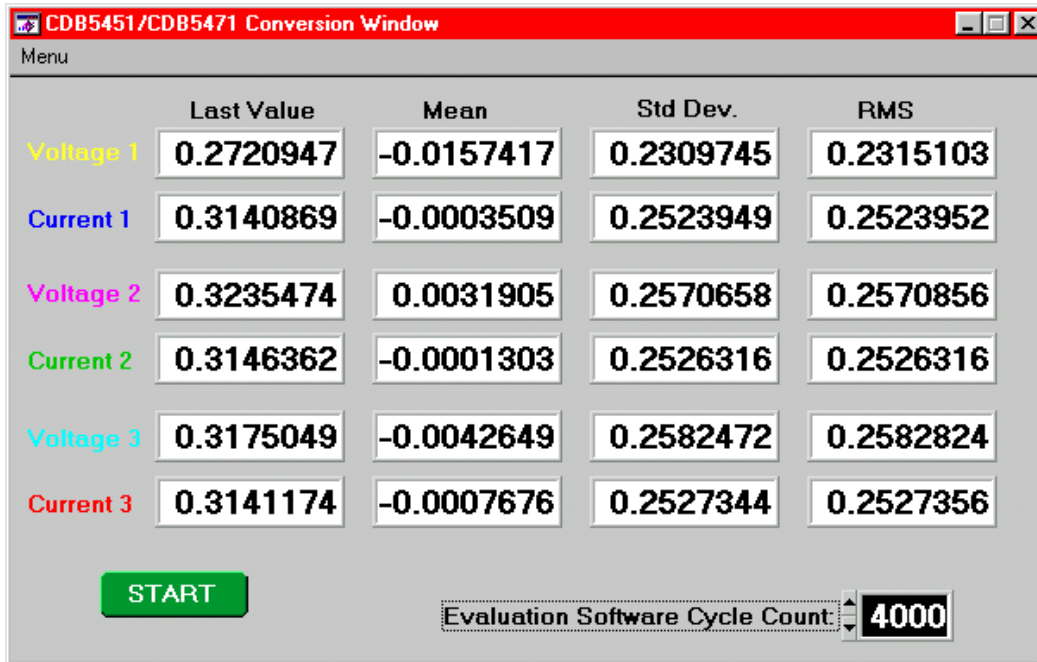

Figure 5. Conversion Window



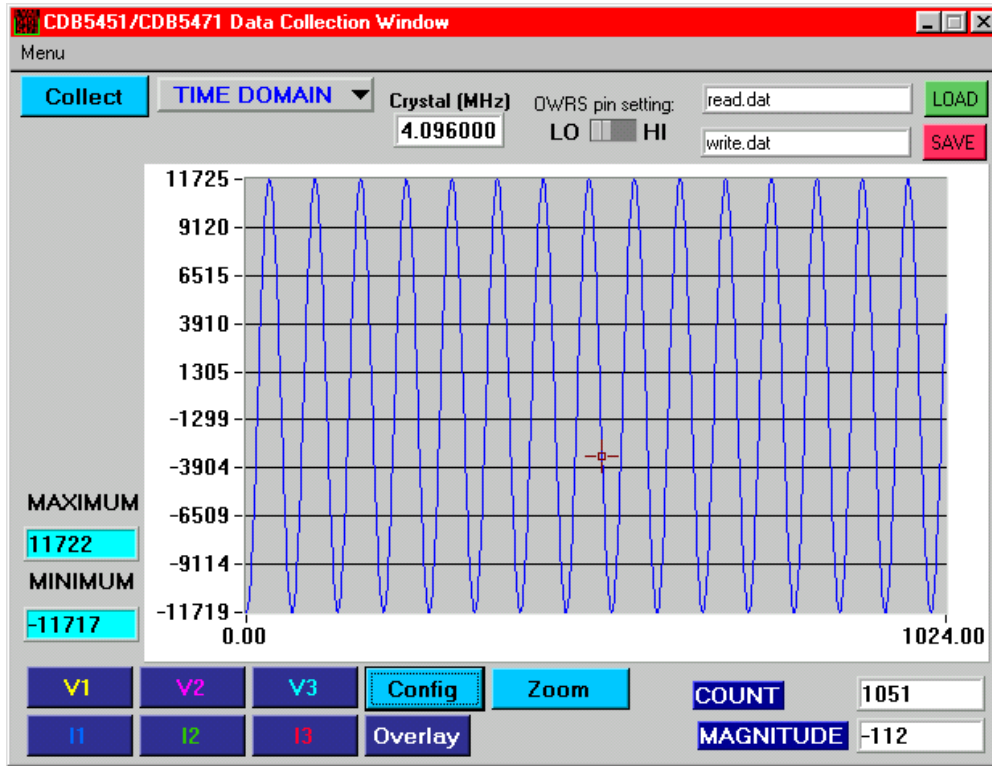

Figure 6. Data Collection Window (Time Domain)

3.2.3.1. Last Value

The first column is labelled as “Last Value.” The value in this box represents the value of the very last instantaneous sample that was taken (for both channels) in the most recently-completed computation cycle. If the user’s analog input waveforms are AC in nature, then this column of results will rarely have any meaning. But if the user applies a constant DC input signal to any of the analog input channels, then the Last Value column for that channel should display an output code that is relatively constant from one conversion cycle to the next.

3.2.3.2. Mean

The values in this column represent the simple average of the sample values in the latest computation cycle.

3.2.3.3. Std Dev.

The values in this column represent the computed standard deviation over the set of values in the most recent computation cycle.

3.2.3.4. RMS

The values in this column represent the computed RMS value over the most recently-completed computation cycle.

3.2.4 Data Collection Window

The Data Collection Window (Figs 6, 8, and 9) allows the user to collect samples sets of data from CS5471 and analyze them using time domain, FFT, and histogram plots. The Data Collection Window is accessible through the Menu option, or by pressing F4.

3.2.4.1. Collect Button

This button will collect data from the CS5471, to be analyzed in the plot area. See the section on Collecting Data Sets for more information.

### 3.2.4.2. *Time Domain / FFT / Histogram Selector*

This selector button is located just to the right of the Collect Button. The label on this button will change as the user selects which analysis is to be performed (“Time Domain” or “FFT” or “Histogram”). When the software is first started, the default mode on this selector button is Time Domain. This user should click on this button to select which type of data processing to perform on the collected data and display in the plot area. Refer to the section on Analyzing Data for more information.

### 3.2.4.3. *“Crystal” Value Indicator Box*

The value in this box reflects the frequency of the CS5451’s clock input (at the XIN pin). Since the XIN frequency affects the sampling rate (the output word rate) of the CS5451, this information must be specified to the software so that it can accurately depict the frequency-content of the sampled data (in Hz) when performing an FFT analysis. The user can enter the crystal frequency that is used on the CDB5451 board into this box. The default value of this box is set for the on-board 4.096MHz oscillator.

### 3.2.4.4. *OWRS Pin Setting:*

This switch should be adjusted whenever the user toggles the S1-1 DIP switch (on the evaluation board). The default setting of this switch is HI, corresponding to the default setting on S1-1 (default setting is “OPEN”). S1-1 drives the CS5471’s OWRS pin to logic “1”. A logic “1” on OWRS sets the sampling frequency of both CS5471 input channels to XIN/1024. To toggle the state of the on-screen switch, simply click on the switch with the mouse.

### 3.2.4.5. *Config Button*

This button will bring up the configuration window (shown in Fig 7) in which the user can modify the data collection specifications. See the discussion of the Config Window in this document.

### 3.2.4.6. *Save Button*

The red-colored SAVE button will save the data in the current plot to a file. The exact path and filename can be specified by the user in the text window located just to the left of the SAVE button. The data collected for both channels will be saved to a text file.

### 3.2.4.7. *Load Button*

The green colored LOAD button will load any data file that was previously generated by clicking on the red SAVE button. The exact path and filename must be specified by the user in the text window located just to the left of the LOAD button.

### 3.2.4.8. *Channel Selector Buttons*

Clicking on buttons labeled as “V1” and “I1” will display a certain channel of data. “V1” refers to the voltage data taken across the Vin1+/Vin1- pins of the CS5471. In a similar manner, clicking on the “I1” button will display the data representing the voltage level across the current channel input pins (In1+/In1-).

## 3.2.5 *Config Window*

See Figure 7. Clicking on the Config button will bring up a small pop-up window called the Config Window. The Config Window allows the user to set up the data collection and analysis parameters, which are described next.

### 3.2.5.1. *Number of Samples*

This box allows the user to select the number of samples to collect. The user can choose any whole-number power of 2 between 16 and 32768.

### 3.2.5.2. *Average*

When performing FFT processing, this box will determine the number of FFTs to average. FFTs will then be collected and averaged when the user clicks on the Collect Button.

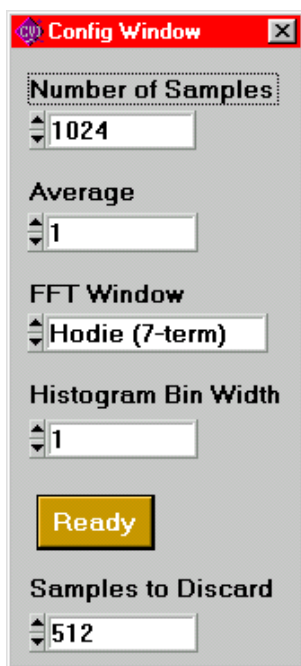

**Figure 7. Configuration Window**

### 3.2.5.3. FFT Window

This box allows the user to select the type of windowing algorithm for FFT processing. Windowing algorithms include the Blackman, Black-Harris, Hanning, 5-term Hodie, and 7-term Hodie. The 5-term Hodie and 7-term Hodie are windowing algorithms developed at Cirrus Logic.

### 3.2.5.4. Histogram Bin Width

This box allows for a variable “bin width” when plotting histograms of the collected data. Each vertical bar in the histogram plot will contain the number of output codes contained in this box. Increasing this number may allow the user to view histograms with larger input ranges.

### 3.2.5.5. Samples to Discard

This number represents the number of CS5471 sample periods that will be ignored before the software starts to collect samples (when the user presses on the Collect Button). After the software has skipped over this many data samples, the software will then begin to save samples from the device (for

all six channels). The number of samples that are actually saved is equal to the number specified in the Number of Samples box.

### 3.2.5.6. Ready Button

After the user has adjusted the parameters in the Config Window to the desired settings, the user must click on the READY button to close the Config Window and return to the Data Collection Window.

## 3.2.6 Analyzing Data

The evaluation software provides three types of analysis tests - Time Domain, Frequency Domain, and Histogram. The Time Domain analysis processes acquired conversions to produce a plot of Output Code versus Conversion Sample Number. The Frequency Domain analysis processes acquired conversions to produce a magnitude versus frequency plot using the Fast-Fourier transform (results up to  $F_s/2$  are calculated and displayed). The Histogram analysis test processes acquired conversions to produce a histogram plot. Statistical noise calculated are also calculated and displayed.

## 3.2.7 Time Domain Information

The following controls and indicators are associated with the Time Domain Analysis. Time domain data can be plotted in the Data Collection Window by setting the Time Domain / FFT / Histogram selector to “Time Domain.”

### 3.2.7.1. Count

Displays current x-position of the cursor on the time domain display.

### 3.2.7.2. Magnitude

Displays current y-value of the cursor on the time domain display.

### 3.2.7.3. Maximum

Indicator for the maximum value of the collected data set.

3.2.7.4. *Minimum*

Indicator for the minimum value of the collected data set.

3.2.8 *Frequency Domain Information*

The following section describes the indicators associated with FFT (Fast-Fourier Transform) analysis. Refer to Figure 8. FFT data can be plotted in the Data Collection Window by setting the Time Domain / FFT / Histogram selector button to "FFT."

3.2.8.1. *Frequency*

Displays the x-axis value of the cursor on the FFT display.

3.2.8.2. *Magnitude*

Displays the y-axis value of the cursor on the FFT display.

3.2.8.3. *S/D*

Indicator for the Signal-to-Distortion Ratio, 4 harmonics are used in the calculations (decibels).

3.2.8.4. *SINAD*

Indicator for the Signal-to-Noise + Distortion Ratio (decibels).

3.2.8.5. *SNR*

Indicator for the Signal-to-Noise Ratio, first 4 harmonics are note included (decibels).

3.2.8.6. *S/PN*

Indicator for the Signal-to-Peak Noise Ratio (decibels).

3.2.8.7. *FS-PdB*

Not using windowing, how far down from zero the peak voltage input value is (decibels).

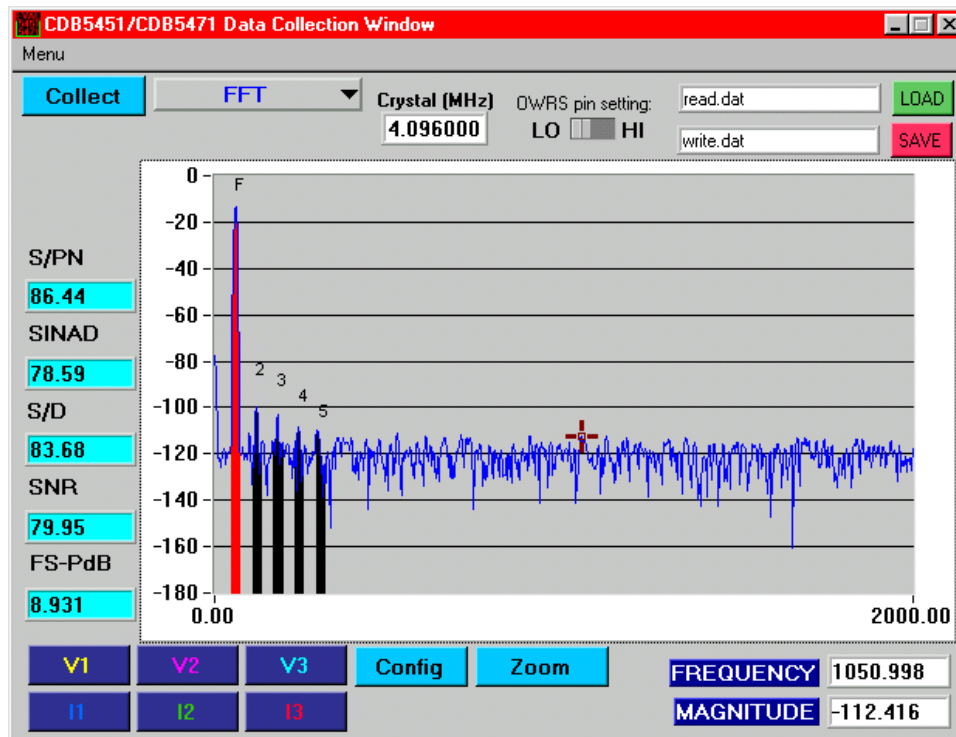

Figure 8. Data Collection Window (FFT)

### 3.2.9 Histogram Information

See figure 9. The following is a description of the indicators associated with Histogram Analysis. Histogram can be plotted in the Data Collection Window by setting the Time Domain / FFT / Histogram selector to “Histogram.”

#### 3.2.9.1. Bin

Displays the x-axis value of the cursor on the Histogram.

#### 3.2.9.2. Magnitude

Indicator for the maximum value of the collected data set.

#### 3.2.9.3. Mean

Average value of the collected data set.

#### 3.2.9.4. Variance

Indicator for the calculated variance of the collected data set.

#### 3.2.9.5. STD\_DEV

Indicator for the calculated standard deviation of the collected data set.

#### 3.2.9.6. Maximum

Indicator for the maximum value of the collected data set.

#### 3.2.9.7. Minimum

Indicator for the minimum value collected in the data set.

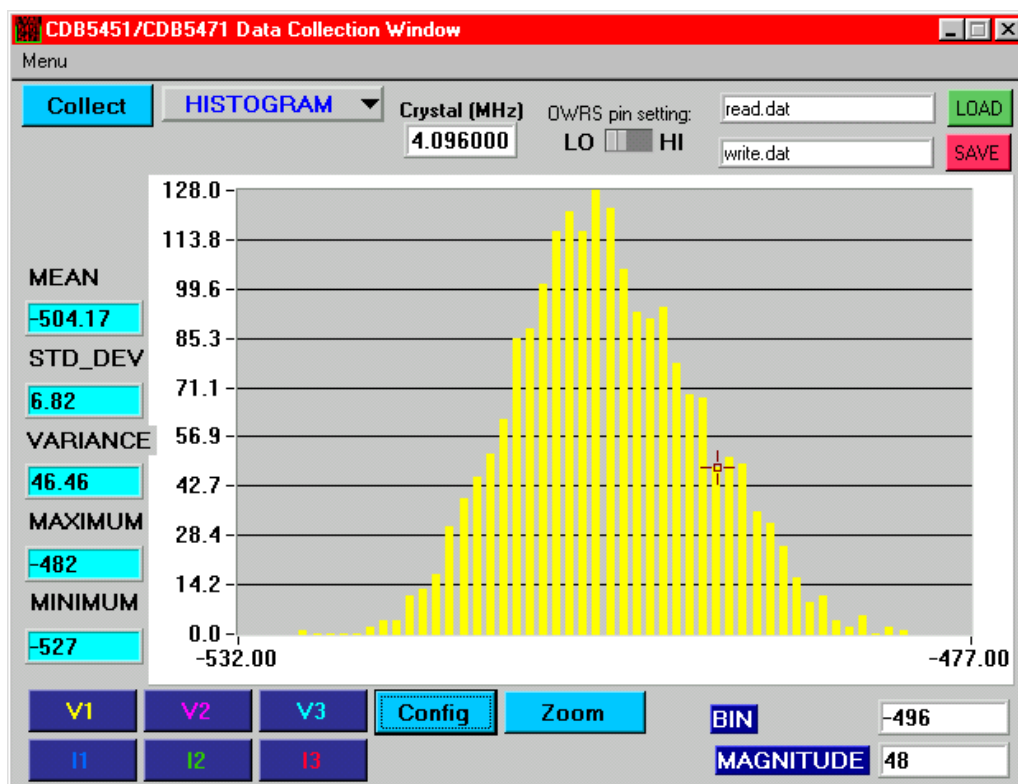

Figure 9. Data Collection Window (Histogram)

CRYSTAL SEMICONDUCTOR  
 CDB5451/71 TSOP Socket Version  
 CDB5451/71-3A.0

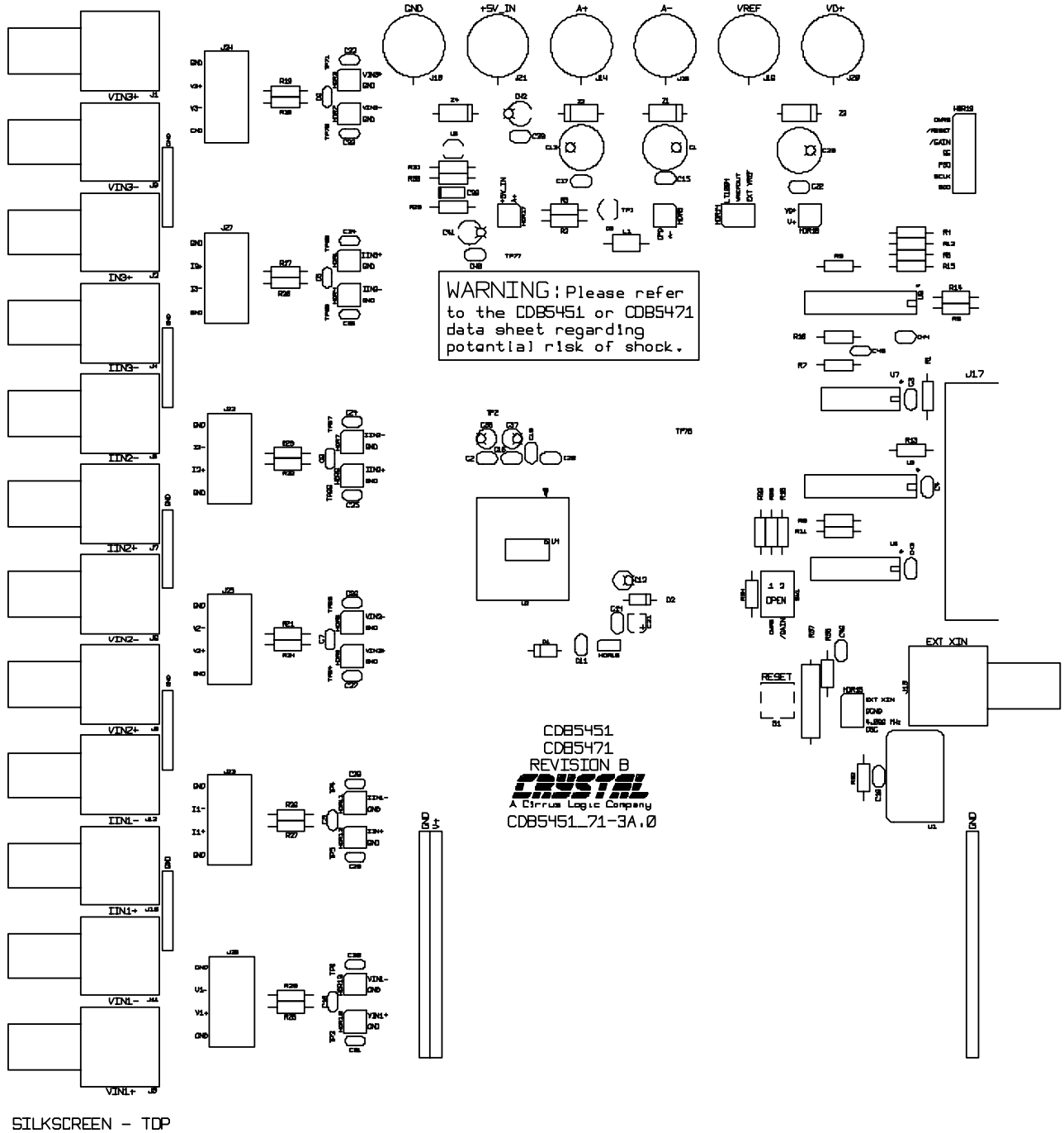
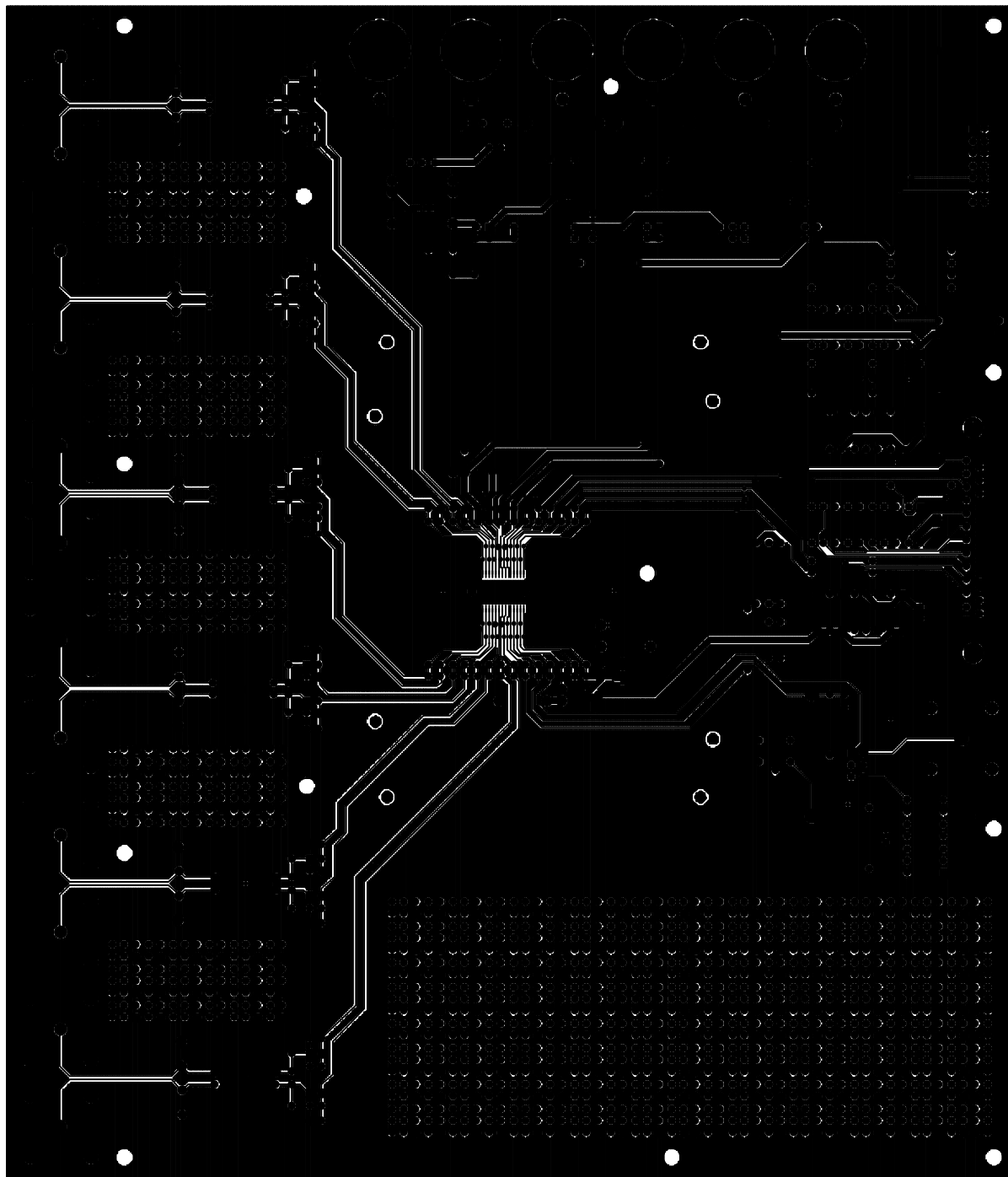

Figure 10. Silkscreen

CRYSTAL SEMICONDUCTOR  
CDB5451/71 TSOP Socket Version  
CDB5451/71-3A.Ø



TOP SIDE

Figure 11. Circuit Side

CRYSTAL SEMICONDUCTOR  
CDB5451/71 TSOP Socket Version  
CDB5451/71-3A.Ø

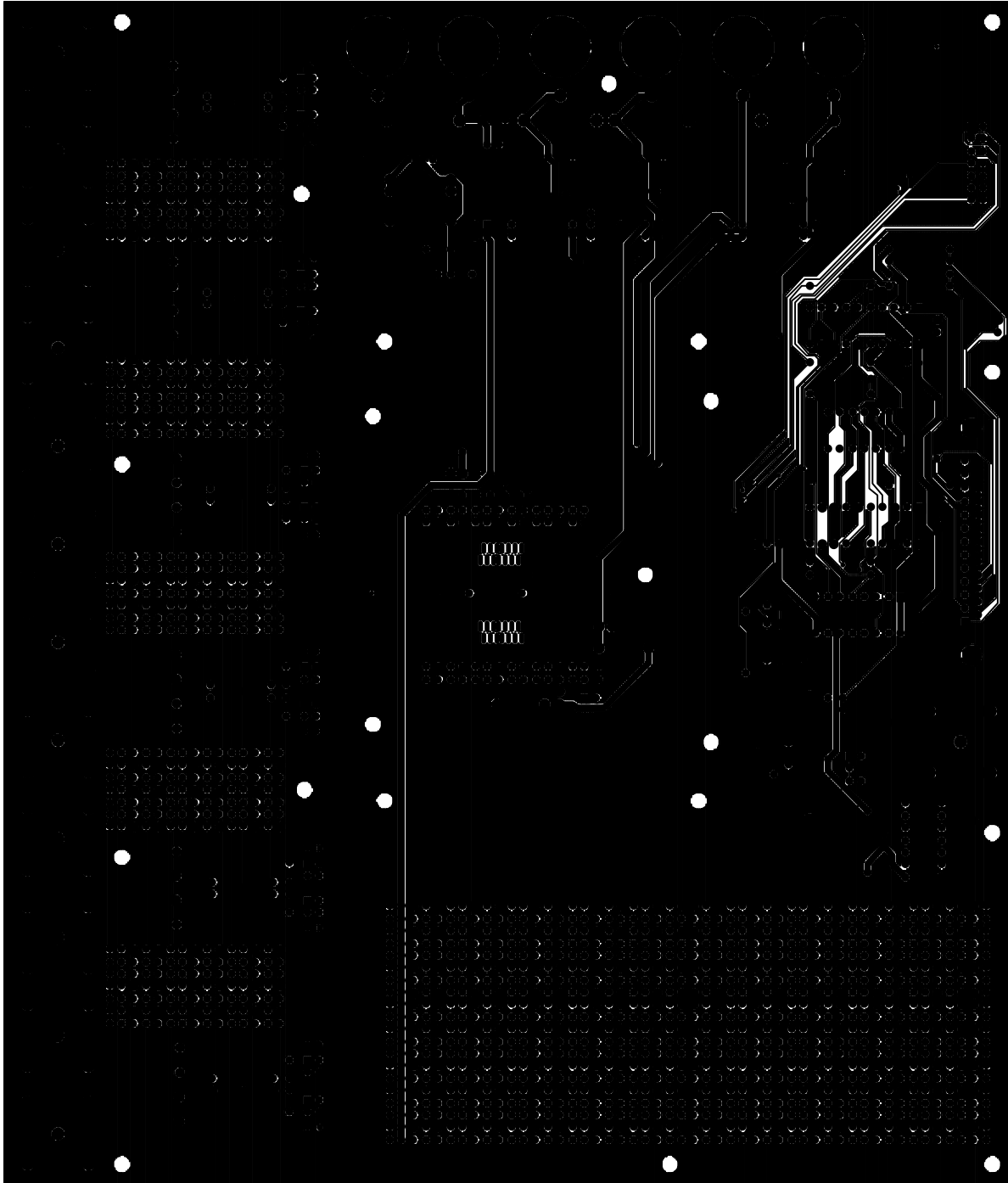

BOTTOM SIDE

**Figure 12. Solder Side**



• **Notes** •

---

SMART  
Analog™